

ZAZA 2 DOUBLE DELTA

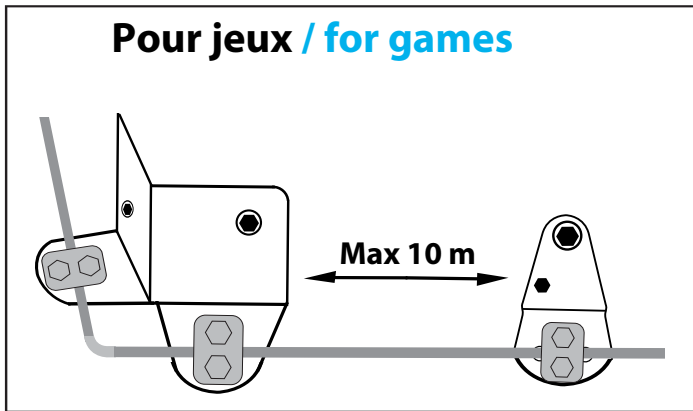

AVANTAGES:

- SPÉCIAL STRUCTURE ARTIFICIELLE / **SPECIAL FOR ARTIFICIAL STRUCTURE**
- VIRAGES à 90° / **REALIZE BENDS OF 90°**
- POLYVALENCE / **FLEXIBILITY**

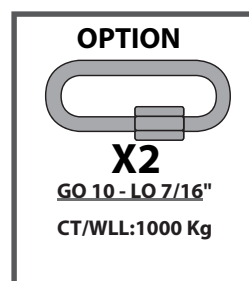
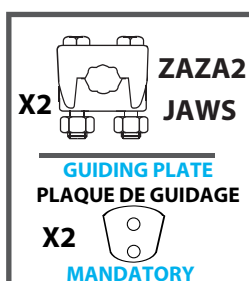
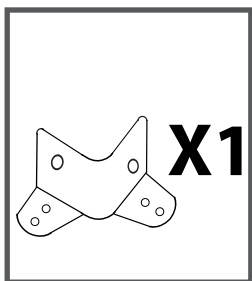
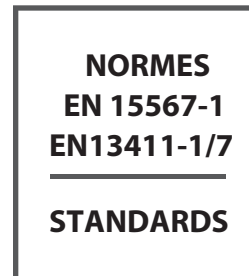
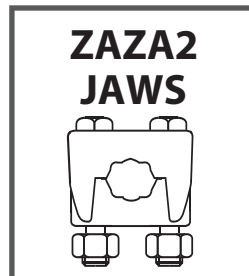

EXEMPLE DE SYSTEME DE FIXATION / **EXAMPLE OF FIXING SYSTEM**

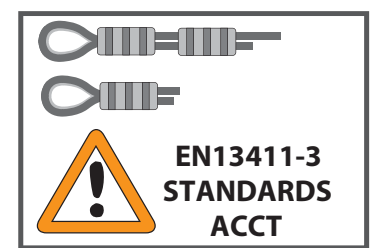
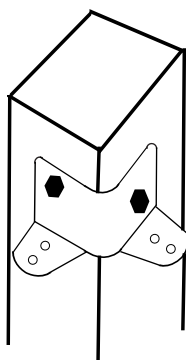

Opération 1

RECOMMANDATION OF ASSEMBLY

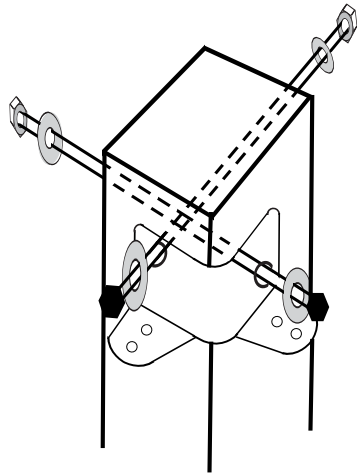

BOLT / BOULON
Ø 12 HR-1/2" HS

THREADED ROD
TIGE FILETÉE
Ø 12HR- 1/2"HS



Operation 2

STARTING & ARRIVAL PLATE / PLATINE DE DEPART & ARRIVÉE

EXEMPLES:

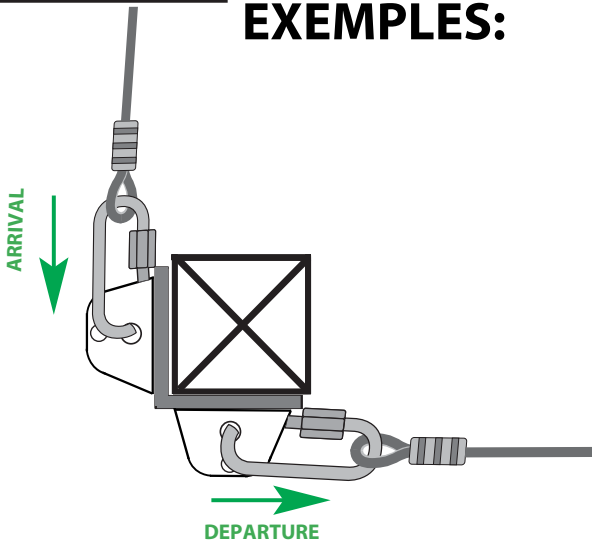

NORMES DE MONTAGE STANDARDS OF ASSEMBLY



EN 15567-1
EN 13411-1/7
STANDARDS - ACCT

X2 MRGO10-LO 7/16"

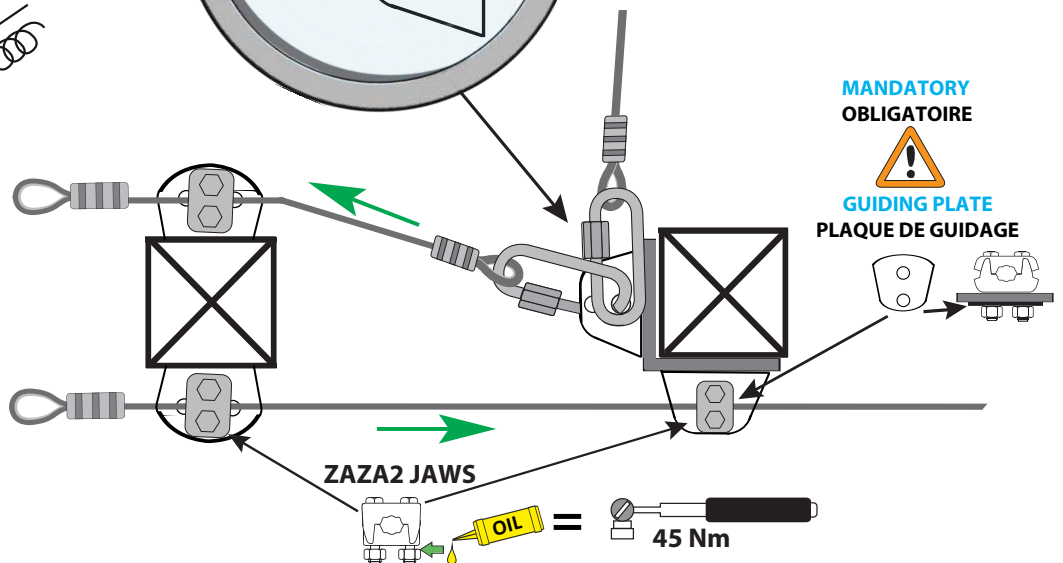
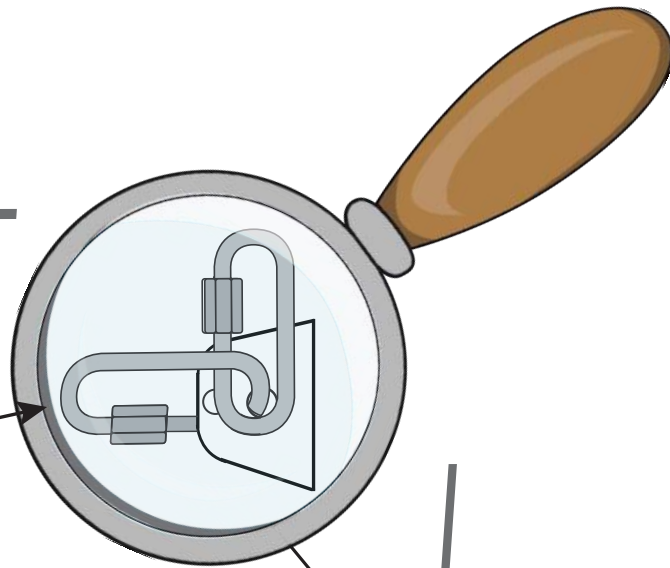

Operation 3

Examples of mounting Combination Exemples de Combinaison de Montage

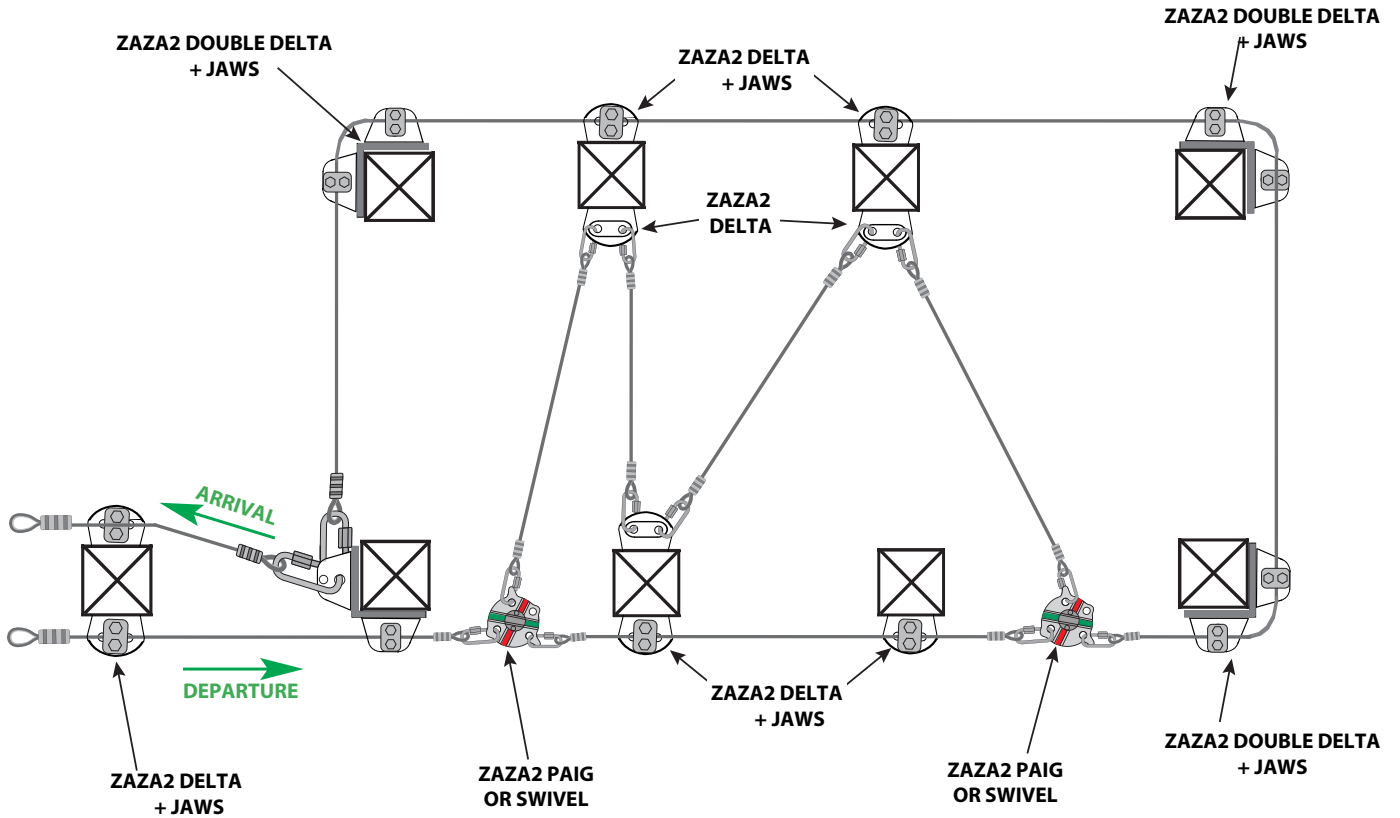

Operation 4

RECOMMANDATION OF ASSEMBLY RECOMMANDATION DE MONTAGE

NORMES DE MONTAGE STANDARDS OF ASSEMBLY



EN 15567-1
EN 13411-1/7
STANDARDS - ACCT

